

### Features

- Dual control wall-mounted.
- Lever handles.
- Stationary spout.
- Less drain.
- 8-1/4" (210 mm) 35° spout from wall to center of drain.
- 1.2 gpm (4.5 lpm) maximum flow rate at 60 psi (4.14 bar).

### Material

- Brass construction.
- KOHLER finishes resist corrosion and tarnishing.

### Required Products/Accessories

K-410-K Wall-mount Valve

### Recommended Products/Accessories

K-23726 Drain treatment  
K-23723 Faucet cleaner

### Optional Products/Accessories

K-7107 Decorative Drain  
K-7108 Decorative Drain  
K-7114 Pop-Up Drain  
K-7124 Pop-Up Clicker Drain  
K-7127 Drain  
K-7129 Drain



ADA CSA B651 OBC

### Codes/Standards







ASME A112.18.1/CSA B125.1  
NSF/ANSI 61  
NSF/ANSI 372  
All applicable US Federal and State material regulations  
DOE - Energy Policy Act 1992  
EPA WaterSense®  
California Energy Commission (CEC)  
ADA  
ICC/ANSI A117.1  
CSA B651  
OBC

### KOHLER® Faucet Lifetime Limited Warranty

See website for detailed warranty information.

### Available Colors/Finishes

*Color tiles intended for reference only.*

Color	Code	Description
	CP	Polished Chrome
	SN	Vibrant® Polished Nickel
	BGD	Vibrant® Moderne Brushed Gold
	G	Brushed Chrome
	BN	Vibrant® Brushed Nickel
	BV	Vibrant® Brushed Bronze

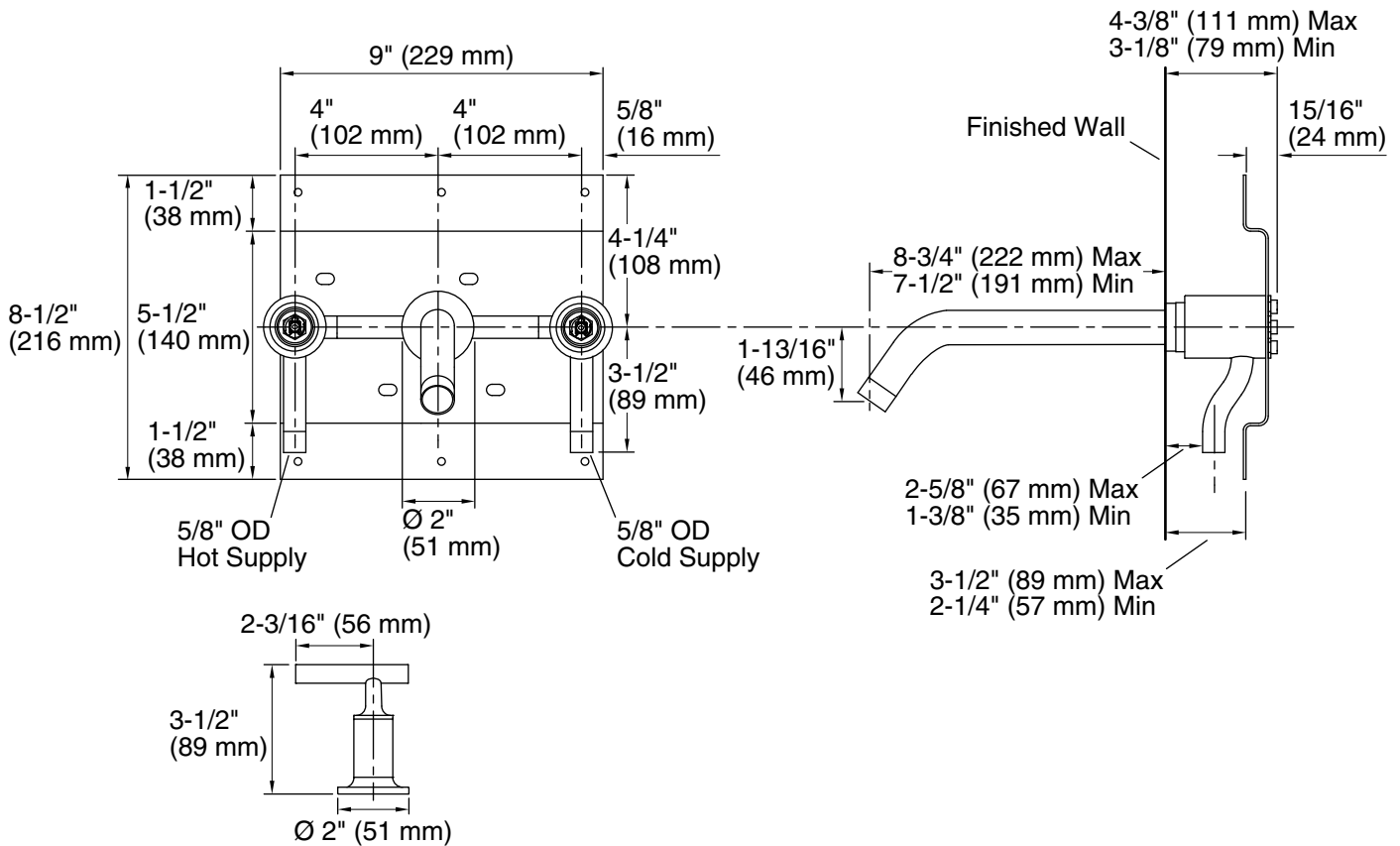

### Technical Information

All product dimensions are nominal.

#### Faucet:

Flow rate: 1.2 gal/min (4.5 l/min)

Pressure: 60 psi (4.1 bar)

#### Spout:

Spout reach: 8-3/4" (222 mm)

### Notes

Install this product according to the installation guide.

The distance between the bottom of spout and top of the fixture rim must not be less than 1-1/2" (38 mm) and not greater than 6" (152 mm).

Three 1-1/2" (38 mm) diameter cutout holes are required for spout and handles.

ADA, OBC, CSA B651 compliant when installed to the specific requirements of these regulations.